

FuelX Installation Manual

Triumph Speed/Scrambler 400

Document Version	1	Release Date	18 Jan 2024
------------------	---	--------------	-------------

Application information	Vehicle Specific
Vehicle	Triumph
Model	Speed/Scrambler 400
Year of manufacture	2024

Note:

- Read through all instructions before installation and use.
- Ensure that the bike is switched off and the key is out of the ignition before proceeding with the installation.
- Some parts of the bikes might be hot/sharp and may cause burns/cuts. Proceed with extreme caution or wait until the bike has cooled down. Always wear safety gloves.
- When the installation is complete, make sure to secure the wiring loom away from the movable parts or components which tend to heat up during the normal operation of the vehicle at any chance.
- FuelX is intended for motorsport use on a closed course, please check with your local laws before using this product. Race Dynamics / PowerTRONIC is not liable for consequences arising out of using the product.

Support:

North & South America : +1 267 214 9292 (Call) +91 9606 044 178 (WhatsApp)

India, Bangladesh, Bhutan, Srilanka & Nepal : +91 9916 229 292 (Call & WhatsApp)

Rest of the world : +91 9606 044 177 (Call & WhatsApp)

Email : support@powertronicecu.com

Website : www.powertronicECU.com



for Indian specification vehicles, the FuelX module will have a sticker indicating it.



The warranty/support will not be provided for international users with Indian specification FuelX purchased from unauthorized re-sellers.

SL No	Chapter	Page
1	About FuelX and Kit Contents	3
2	FuelX Variants	4
3	FuelX Connectors	5
4	FuelX Installation	7-23
5	FuelX Configuration and Settings	24
6	FuelX LEDs	25

Tools required

Serial No	Main tools	Optional tools
1	4mm, 5mm Hex bit	Spinner handle
2	10mm, 8 mm T bar Hexagonal Socket wrench	Ratchet handle
3	Wirecutter	Extension bar or Sliding T-bar

1. FuelX

FuelX is an electronic, plug-in, fuel-injection optimizer for modern engines. It either enriches or decreases the AFR in all operating regions according to the rider requirement. It autotunes the engine to best operational parameters, constantly monitoring, learning, and adapting to the engine condition, wear and tear, riding style, add-ons (such as air filter and/or exhaust), etc as well as the environmental conditions such as temperature, humidity, altitude, etc. always ensuring the engine performs in the safest and most optimal zones.



FuelX kit contains the following items

- FuelX Module
- Wiring Harness
- Handlebar map switch (Pro and Pro+ version only)
- Zip ties
- Decals
- Quick start guide and Warranty card



Image 1.1

2. FuelX Variants:

FuelX Pro+

The FuelX Pro+ variant has 10 maps that can be changed depending on the preference of the rider. For the Pro+ version, the FuelX contains an additional connector (Refer to Image 2.3) for the Handlebar Map switch (Refer to Image 2.2).



Image 2.1



Image 2.2

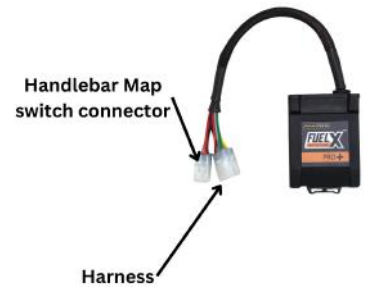

Image 2.3

FuelX Pro

The FuelX Pro variant has 10 maps that can be changed depending on the preference of the rider. For the Pro version, the FuelX contains an additional connector (Refer to Image 2.6) for the Handlebar Map switch (Refer to Image 2.5 m)



Image 2.4



Image 2.5

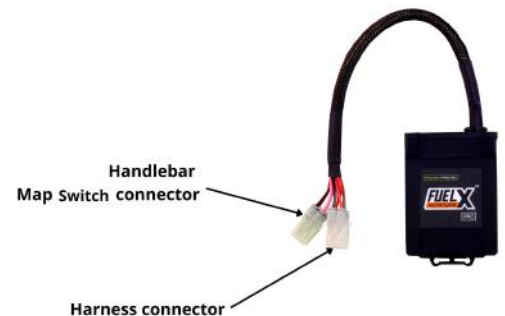

Image 2.6

FuelX Lite

The FuelX Lite variant has a single autotune map and only one connector for the harness.



Image 2.7

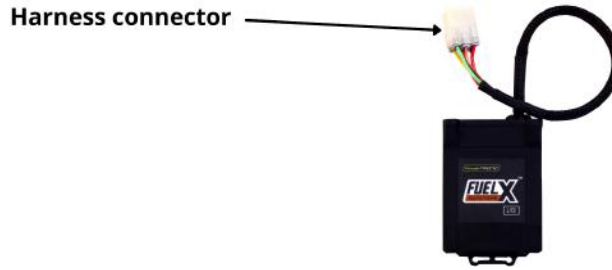

Image 2.7

3. FuelX Harness Connectors

The harness contains

- The Lambda connector (O₂)
- FuelX connector
- Ground/battery negative connector.

The FuelX is connected between the Lambda sensor connector and the ECU. The male connector of FuelX is connected to the female of the Lambda sensor and vice versa.

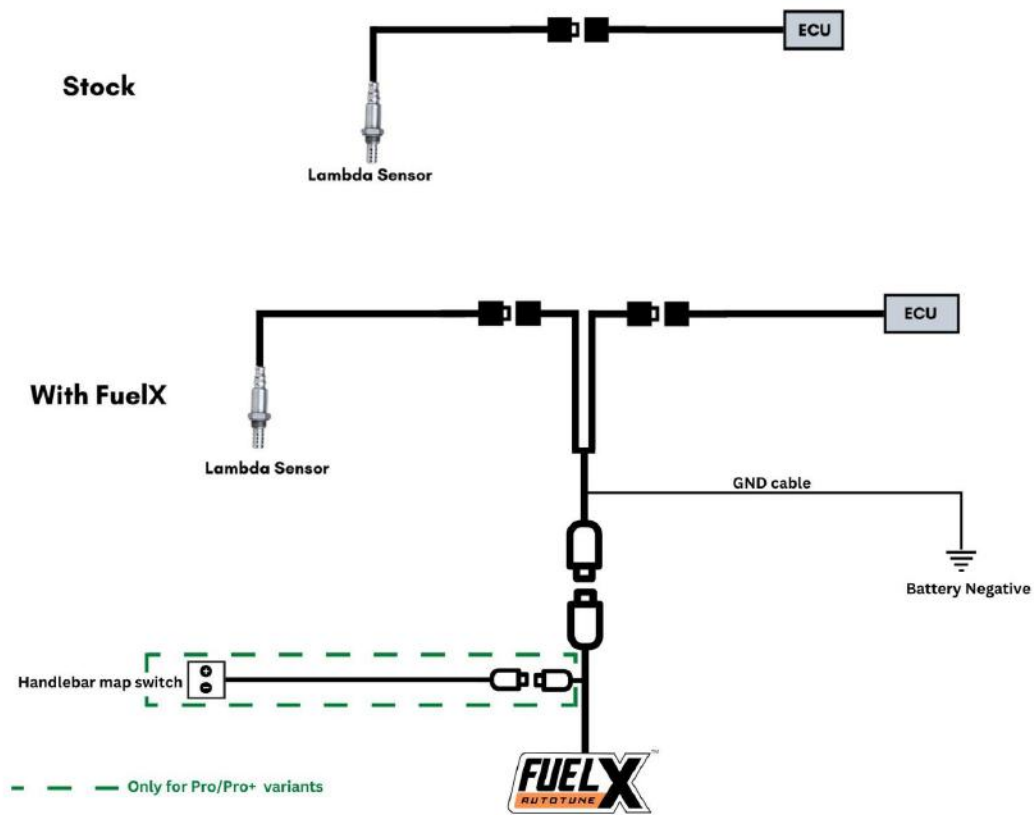

Image 3.4

4. Installation procedure

4.1 Removing panels and tank.

Begin at the left side of the bike.

Park the bike using the center stand on a level surface (Or a paddock stand). Refer to **Image 1**



Image 1

4.1.1 Detach the pillion seat by inserting the key into the keyhole as shown in **Image 2** and unlock the seat. **Image 3** shows the seat detached.



Image 2



Image 3

4.1.3 Unscrew the rear end tank panel bolts using the 5 mm Hexagonal bit. Refer to [Image 5](#).



Image 5

4.1.4 Unscrew the tank mounting bolts. Refer to [Image 6](#).



Image 6

4.1.5 Gently detach the side panel. Refer to [Image 7](#).



Image 7

4.1.6 Unscrew the rear end mounting bolts using the spanner. Refer to **Image 8**.



Image 8

4.1.7 Gently lift the rear end of the tank and locate the vacuum hoses. Detach the hoses carefully. Refer to **Image 9**.



Image 9

4.1.8 Locate the Fuel line and detach the connector carefully. Refer to **Image 10**.

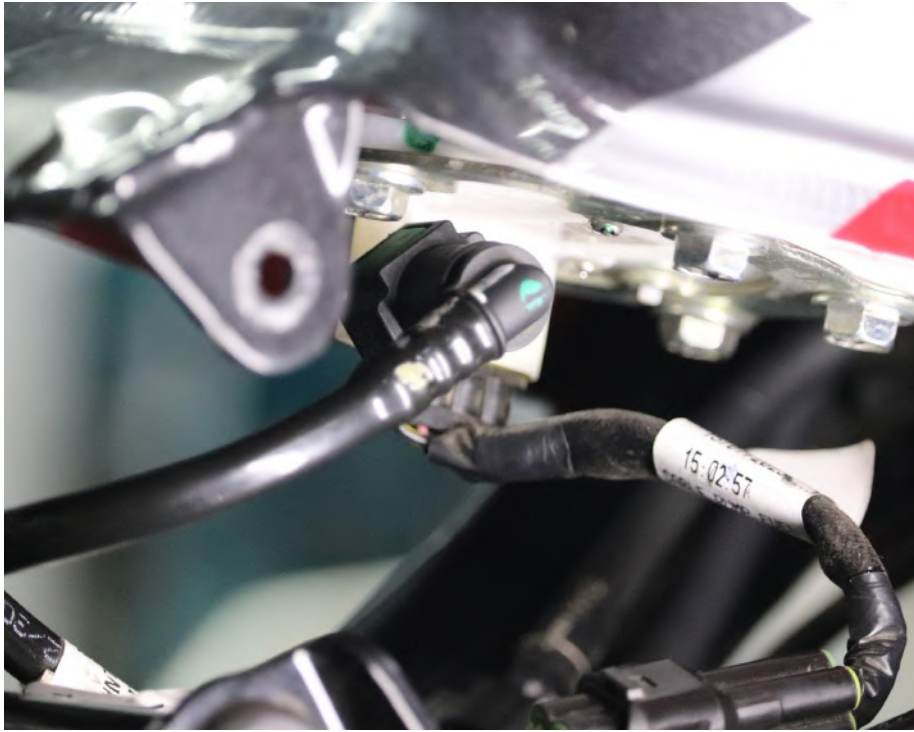

Image 10

4.1.9 Locate the Fuel Pump connector and detach the connector carefully. Refer to **Image 11**



Image 11

4.1.11 Once all the connectors are detached from the tank, gently lift and place it carefully. Refer to **Image 13**



Image 13

4.2 Routing the harness

4.2.1 Locate the stock lambda sensor connector. Refer to [Image 21](#).

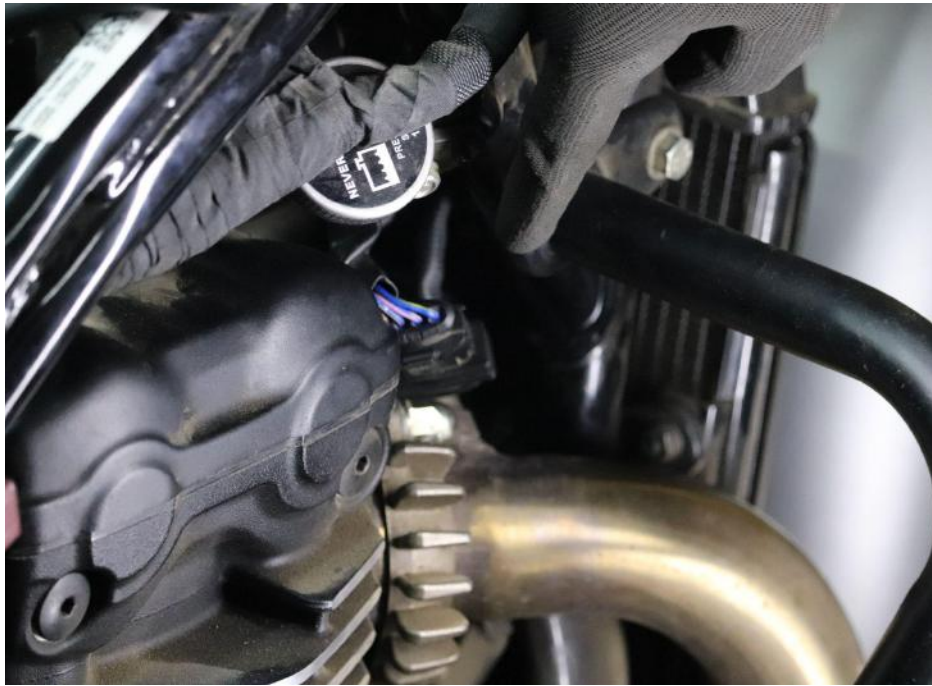

Image 21

4.2.2 Disconnect the stock Lambda sensor connector. Refer to the [Image 22](#).



Image 22

4.2.3 Connect FuelX female Lambda sensor connector to stock male connector. Refer to [Image 23](#).



Image 23

4.2.4 Connect FuelX male Lambda sensor connector to stock female connector. Refer to [Image 24](#).



Image 24

4.2.5 Connect the FuelX Handlebar map switch on the Handlebar. Refer to Image **Image 25**



Image 25

4.2.6 Using a 2.5 mm Allen key, tighten the bolts. Refer to Image **Image 26**.

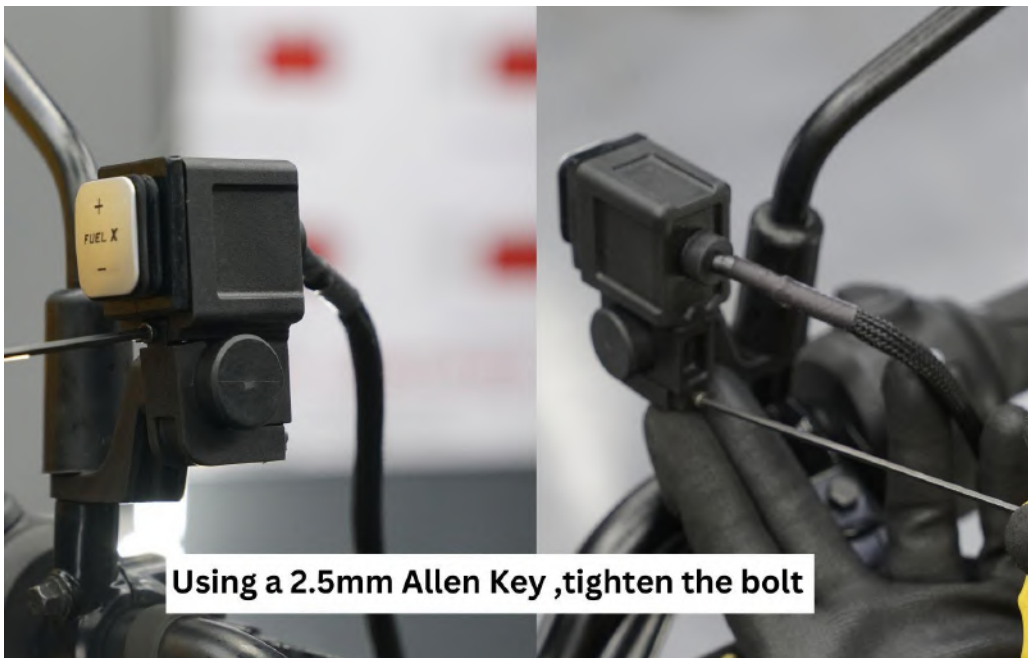

Image 26

4.2.7 Route the FuelX harness and handlebar switch wire. Refer to Image **Image 27**

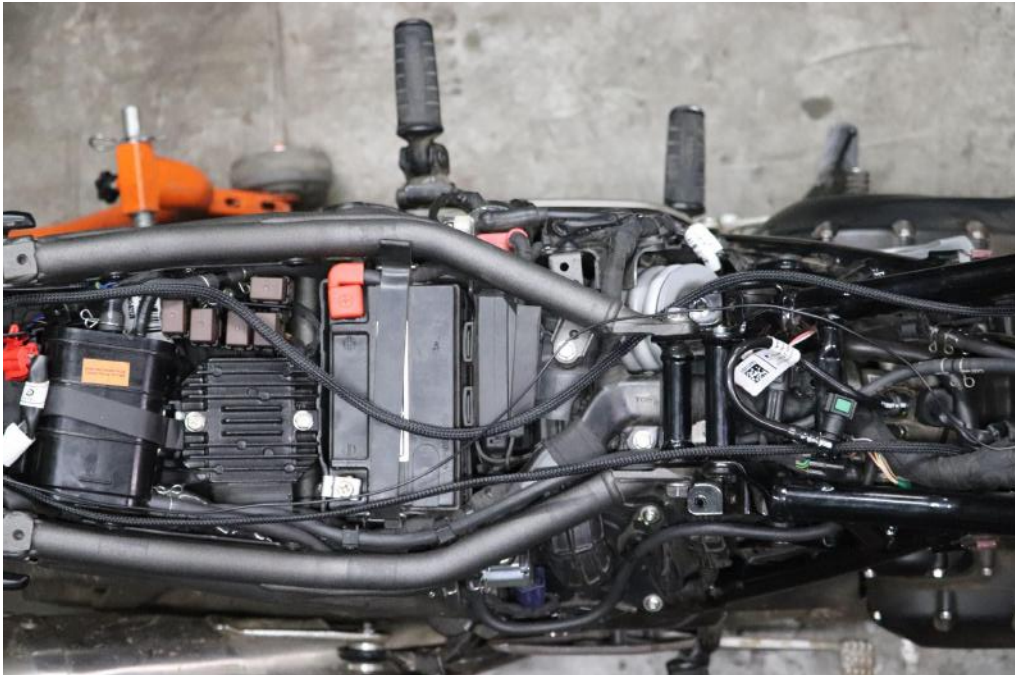

Image 27

4.2.7 Place the FuelX module under the seat on top of the battery. Refer to Image **Image 28.**

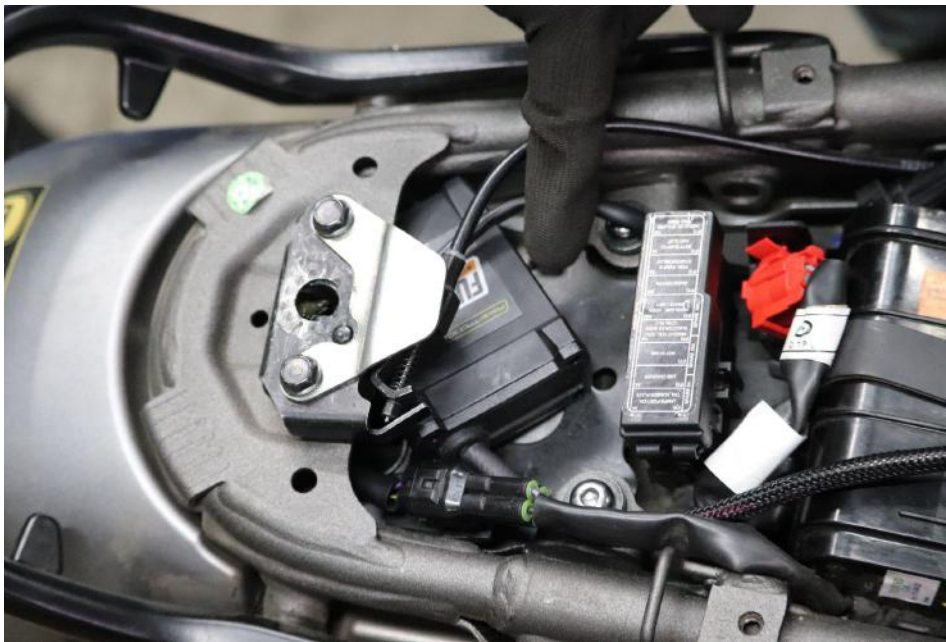

Image 28

4.2.8 Connect the 6-pin FuelX connector to the harness. Refer to **Image 29**



Image 29

4.2.9 Connect the 4-pin FuelX connector to the handlebar map switch harness. Refer to the **Image 30.**



Image 30

4.2.10 Connect the Ground cable to the battery **negative terminal**. Terminal position may vary. Refer to the **Image 31**

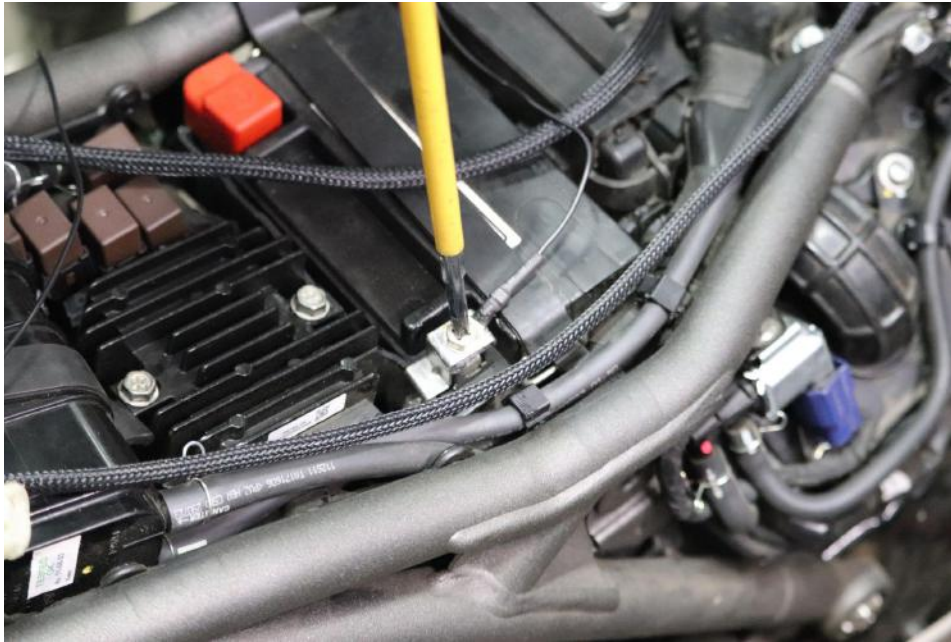

Image 31

4.2.11 Secure the harness from hot and moving parts using the zip ties provided.

4.2.12 Attach the panels and the tank back.

5. FuelX Configurations and Settings

For Pro+ and Pro versions, maps on the FuelX can be changed according to the preference of the customer. By just pressing the +/- button on the Handlebar map switch. The **Green LED** on the FuelX Handlebar map switch will help the customer know which map is active. Ie the number of blinks on the handlebar switch indicates the number of maps.

Map No	Map Description
1	LEAN (Less Fuel)
2	
3	STOCK
4	
5	
6	
7	
8	
9	
10	RICH (More Fuel)

Image 32

The rider can choose the map according to the fuel enrichment he wants.

The first two maps are lean.

Map 3 runs with stock AFR set by the OEM manufacturer.

Maps 4 from 10 make the AFR richer as the numbers go higher.

For Lite versions, a single autotune map is provided for adjusting the AFR for the best operational parameters.

6. FuelX LEDs

FuelX has LEDs on the module to indicate the operation.

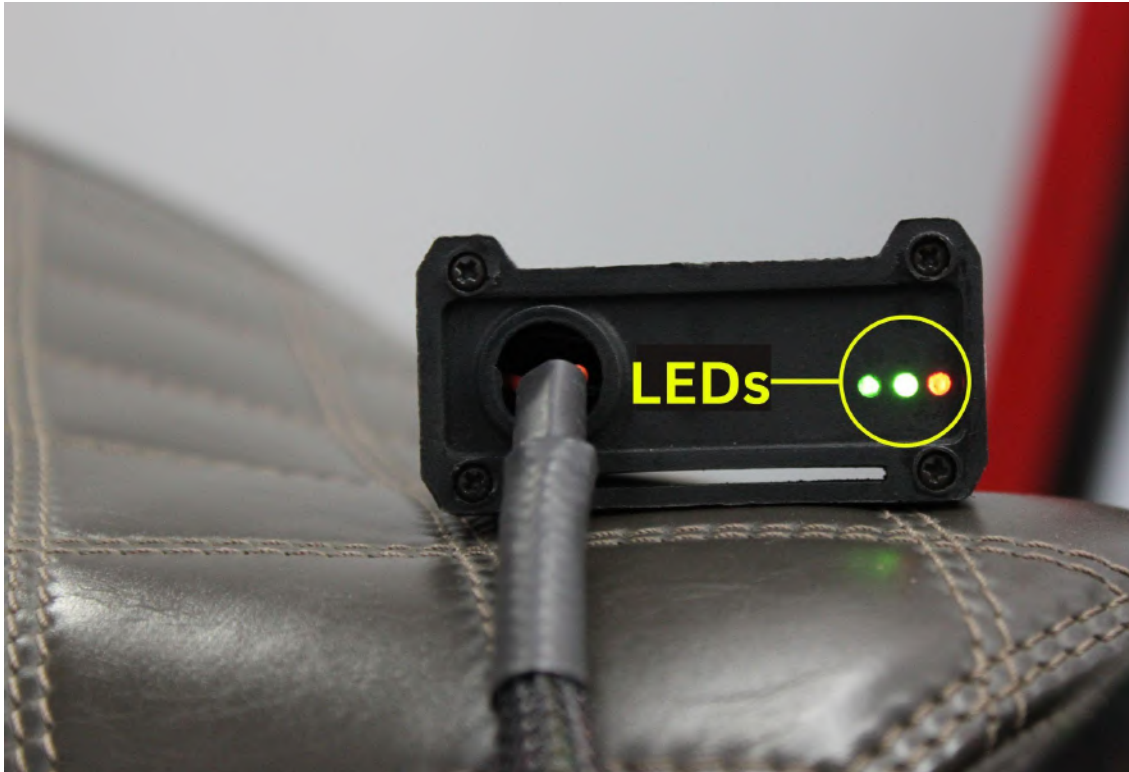

Image 33

The blinking of the **Red LED** indicates that the Map on the FuelX is being activated. The Red LED starts blinking after the key and the kill switch are on.

The blinking of the **Green LEDs** during the idling of the engine indicates that the FuelX is working in sync with the OEM ECU.

The working of both Green and Red LEDs indicates the FuelX Functioning as intended.