

FuelX Installation Manual

Suzuki V Storm 250 SX (2022-2023)

| | | | |
|------------------|---|--------------|-------------|
| Document Version | 1 | Release Date | 18 Jan 2024 |
|------------------|---|--------------|-------------|

| | |
|-------------------------|-----------------------|
| Application information | Vehicle Specific |
| Vehicle | Suzuki |
| Model | V Storm 250 SX |
| Year of manufacture | (2022-2023) |

Note:

- Read through all instructions before installation and use.
- Ensure that the bike is switched off and the key is out of the ignition before proceeding with the installation.
- Some parts of the bikes might be hot/sharp and may cause burns/cuts. Proceed with extreme caution or wait until the bike has cooled down. Always wear safety gloves.
- When the installation is complete, make sure to secure the wiring loom away from the movable parts or components which tend to heat up during the normal operation of the vehicle at any chance.
- FuelX is intended for motorsport use on a closed course, please check with your local laws before using this product. Race Dynamics / PowerTRONIC is not liable for consequences arising out of using the product.

Support:

North & South America : +1 267 214 9292 (Call) +91 9606 044 178 (WhatsApp)

India, Bangladesh, Bhutan, Srilanka & Nepal : +91 9916 229 292 (Call & WhatsApp)

Rest of the world : +91 9606 044 177 (Call & WhatsApp)

Email : support@powertronicecu.com

Website : www.powertronicECU.com



for Indian specification vehicles, the FuelX module will have a sticker indicating it.



The warranty/support will not be provided for international users with Indian specification FuelX purchased from unauthorized re-sellers.

| SL No | Chapter | Page |
|-------|----------------------------------|------|
| 1 | About FuelX and Kit Contents | 3 |
| 2 | FuelX Variants | 4 |
| 3 | FuelX Connectors | 5 |
| 4 | FuelX Installation | 7-23 |
| 5 | FuelX Configuration and Settings | 24 |
| 6 | FuelX LEDs | 25 |

Tools required

| Serial No | Main tools | Optional tools |
|-----------|--|--------------------------------|
| 1 | 4mm, 5mm Hex bit | Spinner handle |
| 2 | 10mm, 8 mm T bar Hexagonal Socket wrench | Ratchet handle |
| 3 | Wirecutter | Extension bar or Sliding T-bar |

1. FuelX

FuelX is an electronic, plug-in, fuel-injection optimizer for modern engines. It either enriches or decreases the AFR in all operating regions according to the rider requirement. It autotunes the engine to best operational parameters, constantly monitoring, learning, and adapting to the engine condition, wear and tear, riding style, add-ons (such as air filter and/or exhaust), etc as well as the environmental conditions such as temperature, humidity, altitude, etc. always ensuring the engine performs in the safest and most optimal zones.



FuelX kit contains the following items

- FuelX Module
- Wiring Harness
- Handlebar map switch (Pro and Pro+ version only)
- Zip ties
- Decals
- Quick start guide and Warranty card



Image 1.1

2. FuelX Variants:

FuelX Pro+

The FuelX Pro+ variant has 10 maps that can be changed depending on the preference of the rider. For the Pro+ version, the FuelX contains an additional connector (Refer to Image 2.3) for the Handlebar Map switch (Refer to Image 2.2).



Image 2.1



Image 2.2

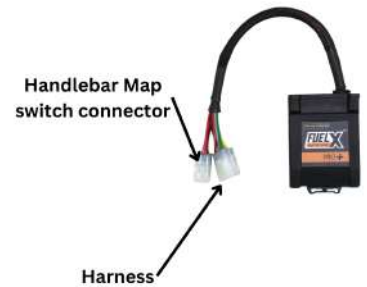

Image 2.3

FuelX Pro

The FuelX Pro variant has 10 maps that can be changed depending on the preference of the rider. For the Pro version, the FuelX contains an additional connector (Refer to Image 2.6) for the Handlebar Map switch (Refer to Image 2.5 m)



Image 2.4



Image 2.5

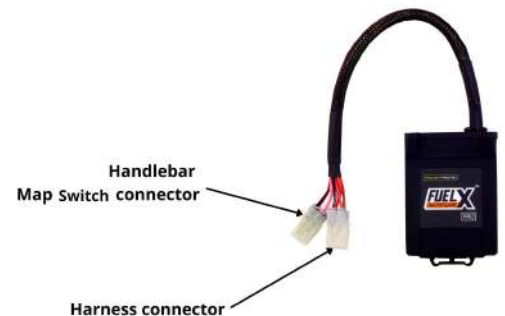

Image 2.6

FuelX Lite

The FuelX Lite variant has a single autotune map and only one connector for the harness.



Image 2.7

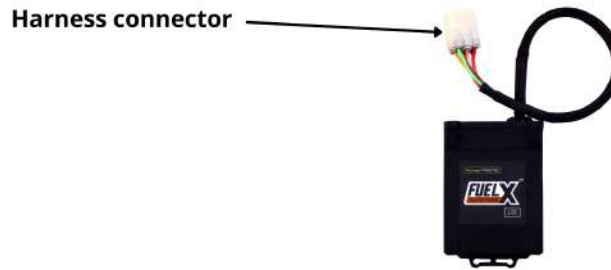

Image 2.7

3. FuelX Harness Connectors

The harness contains

- The Lambda connector (O₂)
- FuelX connector
- Ground/battery negative connector.

The FuelX is connected between the Lambda sensor connector and the ECU. The male connector of FuelX is connected to the female of the Lambda sensor and vice versa.

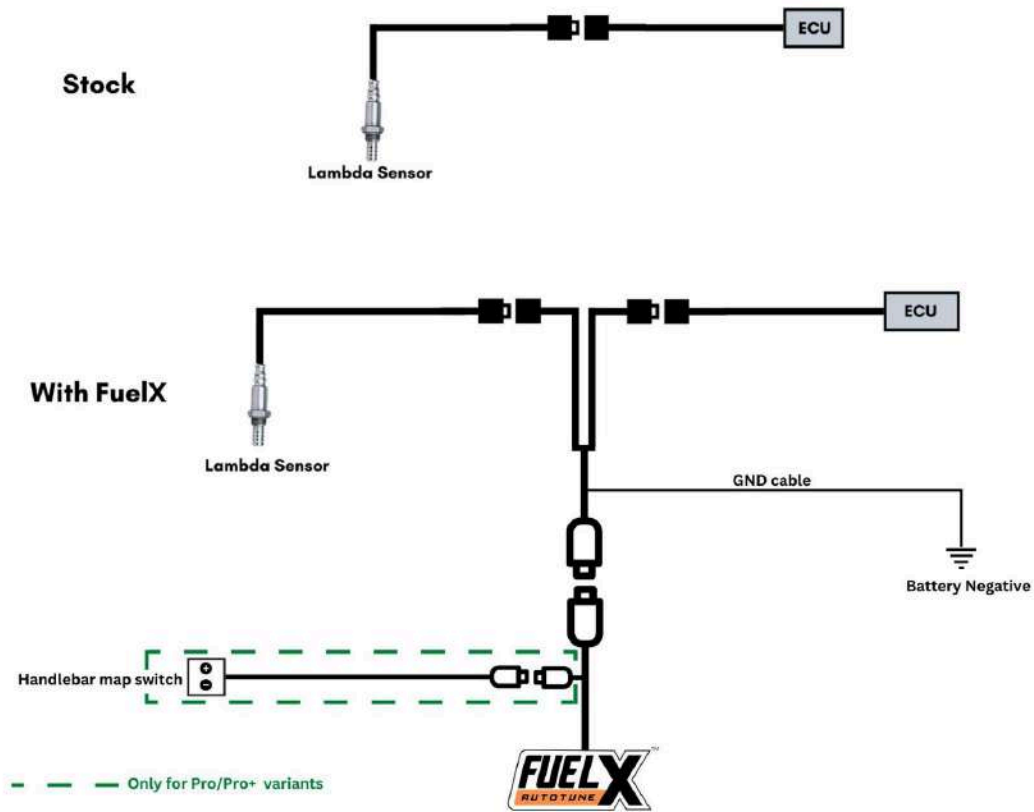

Image 3.4

4. Installation procedure

4.1 Removing panels and tank.

Begin at the left side of the bike.

Park the bike using the center stand on a level surface (Or a paddock stand). Refer to **Image 1**



Image 1

4.1.1 Detach the pillion seat by inserting the key into the keyhole as shown in **Image 2** and unlock the seat. **Image 3** shows the seat detached.

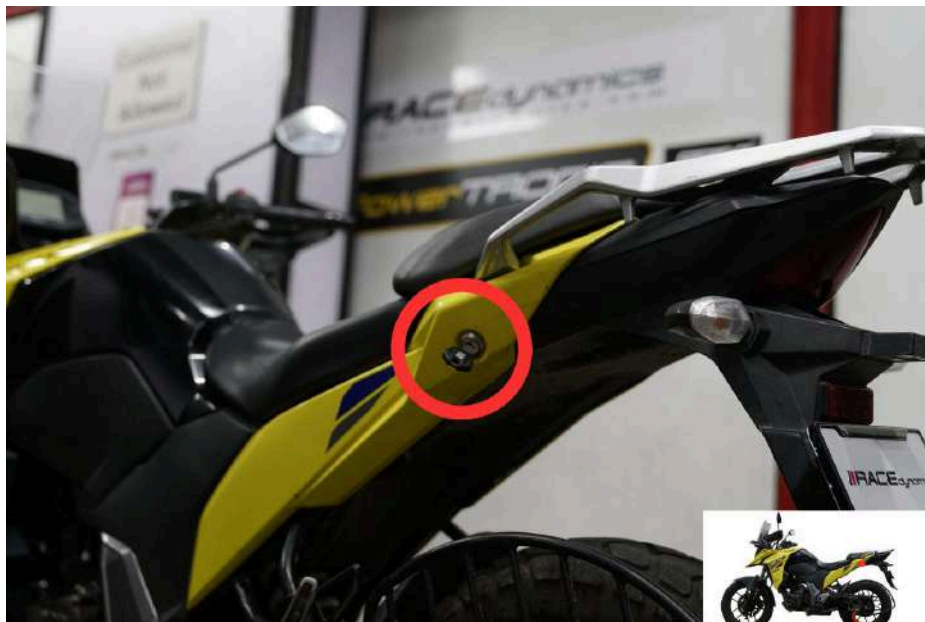

Image 2



Image 3

4.1.2 Unscrew the Rider seat mounting bolts using the 5mm Hex Bit. Refer to **Image 4.**



Image 4



Image 5

4.1.3 Unscrew the panel bolts using the 5 mm Hexagonal bit. Refer to [Image 6](#).



Image 6

4.1.4 Unscrew the bottom panel bolts using the 5 mm Hexagonal bit Refer to **Image 7**.

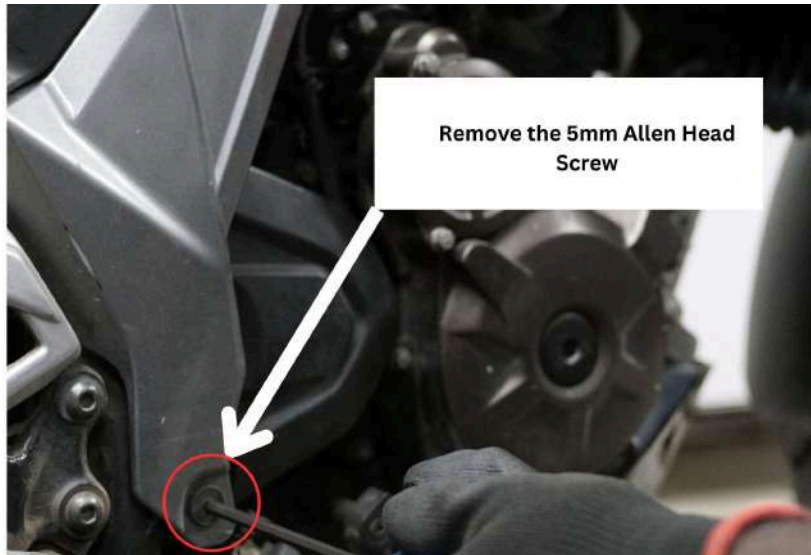

Image 7

4.1.5 Using a Sharp tool remove the Pressing Clip. Refer to **Image 8**.



Image 8

4.1.6 Once the 5mm Allen head screws and pressing clip are removed, gently detach the right side panel.
Refer to **Image 9**



Image 9

4.2 Routing the harness



Image 10

4.2.1 Locate the stock lambda sensor connector on the Right side of the bike. Refer to **Image 11**.



Image 11

4.2.2 Disconnect the stock Lambda sensor connector. Refer to the **Image 12.**



Image 12

4.2.3 Connect FuelX female Lambda sensor connector to stock male connector. Refer to **Image 13.**

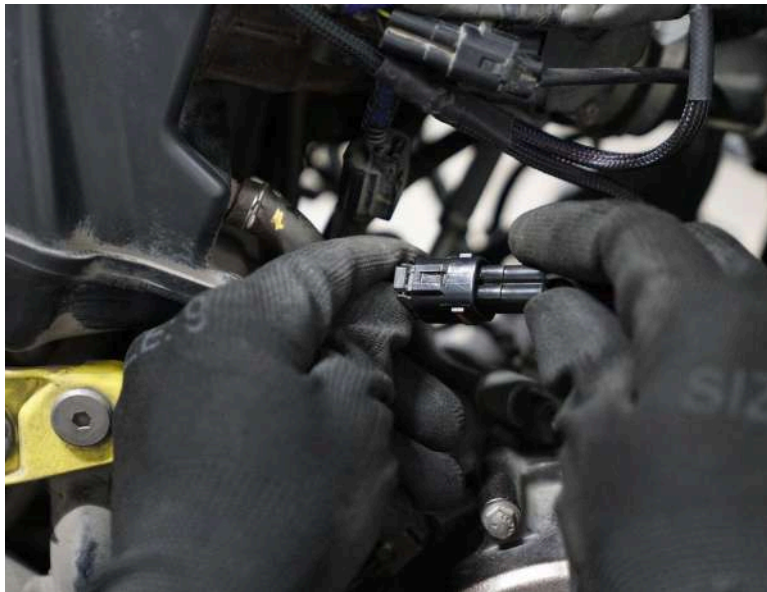

Image 13

4.2.4 Connect FuelX male Lambda sensor connector to stock female connector. Refer to [Image 14](#).

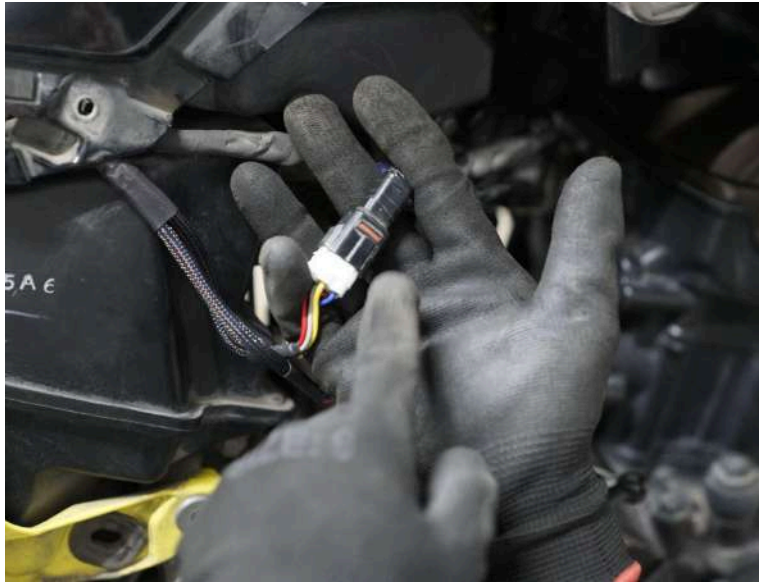

Image 14

4.2.5 Connect the FuelX Handlebar map switch on the Handlebar. Refer to [Image 15](#)



Image 15

4.2.6 Using a 2.5 mm Allen key, tighten the bolts. Refer to Image [Image 16](#).



Image 16

4.2.8 Place the FuelX module under the rear seat. Refer to Image [Image 17](#).



Image 17

4.2.9 Connect the 6-pin FuelX connector to the harness. Refer to **Image 18.**



Image 18

4.2.10 Connect the 4-pin FuelX connector to the handlebar map switch harness. Refer to the **Image 19 & Image 20.**

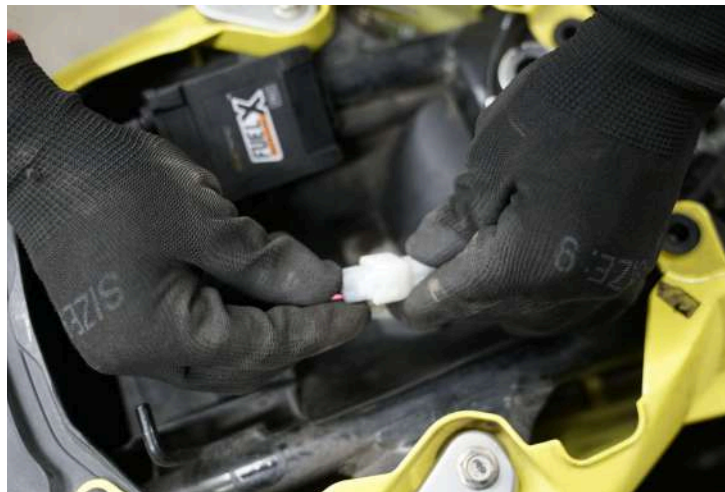

Image 19



Image 20

4.2.11 Connect the Ground cable to the battery **negative terminal**. Terminal position may vary. Refer to the **Image 21**



Image 21

4.2.12 Secure the harness from hot and moving parts using the zip ties provided.

4.2.13 Attach the panels and the tank back.

5. FuelX Configurations and Settings

For Pro+ and Pro versions, maps on the FuelX can be changed according to the preference of the customer. By just pressing the +/- button on the Handlebar map switch. The **Green LED** on the FuelX Handlebar map switch will help the customer know which map is active. Ie the number of blinks on the handlebar switch indicates the number of maps.

| Map No | Map Description |
|--------|------------------|
| 1 | LEAN (Less Fuel) |
| 2 | |
| 3 | STOCK |
| 4 | |
| 5 | |
| 6 | |
| 7 | |
| 8 | |
| 9 | |
| 10 | RICH (More Fuel) |

Image 32

The rider can choose the map according to the fuel enrichment he wants.

The first two maps are lean.

Map 3 runs with stock AFR set by the OEM manufacturer.

Maps 4 from 10 make the AFR richer as the numbers go higher.

For Lite versions, a single autotune map is provided to adjust the AFR for the best operational parameters.

6. FuelX LEDs

FuelX has LEDs on the module to indicate the operation.

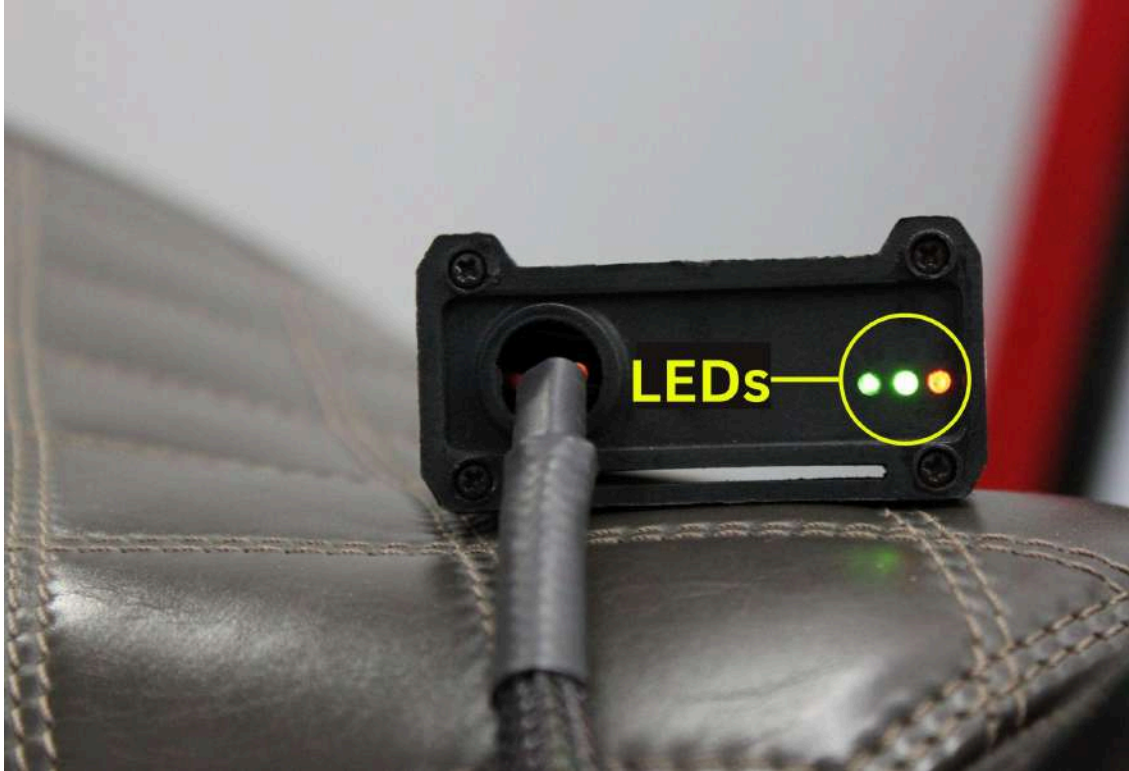

Image 33

The blinking of the **Red LED** indicates that the Map on the FuelX is being activated. The Red LED starts blinking after the key and the kill switch are on.

The blinking of the **Green LEDs** during the idling of the engine indicates that the FuelX is working in sync with the OEM ECU.

The working of both Green and Red LEDs indicates the FuelX Functioning as intended.